



BRAKE PAD

P 06 081

The P 06 081 brake pad is synonymous with reliability

The Brembo brake pad guarantees ultimate safety when braking thanks to the use of more than 100 different compounds, designed according to the type of vehicle and use. Stopping distances reduced to a minimum, maximum driving comfort and silent operation are the most important features of Brembo materials. Brembo brake pads are supplied together with an extensive range of accessories and assembly kits for professional-standard installation.

- ✓ OE-equivalent
- ✓ Brembo quality
- ✓ ECE-R90 certificate
- ✓ Safety
- ✓ Performance
- ✓ Comfort
- ✓ With accessories



Technical specifications

EAN code 8020584102756	Axle Front	Thickness 20 mm
Width 155 mm	Height 68 mm	Braking system Teves
Wear indicator Prepared for wear indicator	WVA number 24161,23313	Accessories With accessories With anti-squeal shim With piston clip

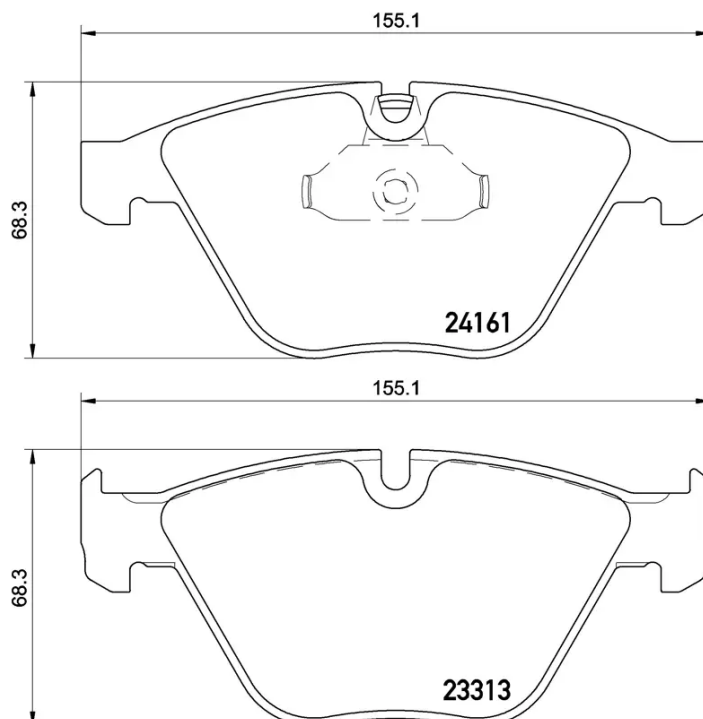



COMPATIBLE OE PART NUMBERS

34112288870	BMW
-------------	-----

34112288871	BMW
-------------	-----

34112288873	BMW
-------------	-----

34112288874	BMW
-------------	-----

34116776161	BMW
-------------	-----

34116783542	BMW
-------------	-----

34116790760	BMW
-------------	-----

34116794917	BMW
-------------	-----

34116794920	BMW
-------------	-----