



BRAKE DISC PAINTED

09.A958.21

The 09.A958.21 painted brake disc is synonymous with reliability

The Brembo brake disc with special UV paint treatment guarantees superior corrosion resistance for the product, thanks to the protective coating on the outer edges and on the disc hub. The UV paint not only gives the disc a clean, shiny appearance but is also beneficial for the environment as the water-based UV paint treatment does not require the use of chemical solvents and is a low energy consumption process.



- ✓ OE-equivalent
- ✓ Brembo quality
- ✓ ECE-R90 certificate
- ✓ Safety
- ✓ High carbon
- ✓ Anti-corrosion
- ✓ PVT ventilation
- ✓ Fastening screws

Technical specifications

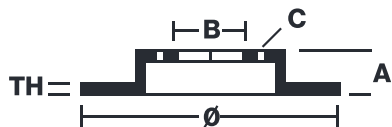

EAN code
8020584039236

Axle
Front

Diameter Ø
350 mm

Thickness (TH)
32 mm

Height (A)
55 mm

Number of holes (C)
5

Brake disc type
Ventilated

Centering (B)
67 mm

Min. thickness
29,4 mm

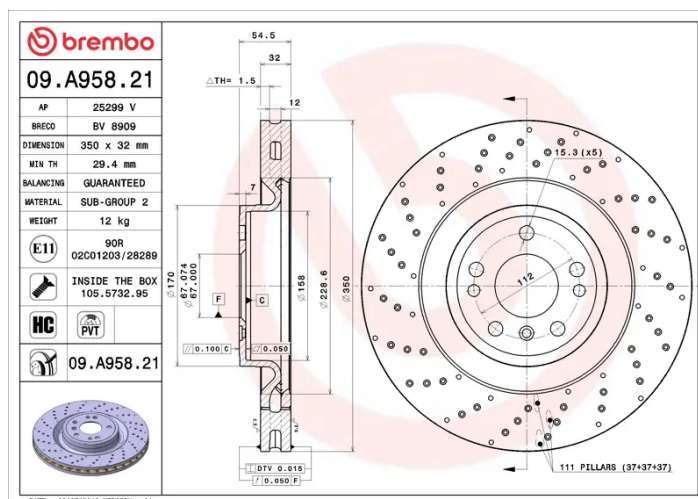

COMPATIBLE OE PART NUMBERS

1664210412	MERCEDES-BENZ
------------	---------------

1664211012	MERCEDES-BENZ
------------	---------------

1664211500	MERCEDES-BENZ
------------	---------------

A1664210412	MERCEDES-BENZ
-------------	---------------

A1664211012	MERCEDES-BENZ
-------------	---------------

A1664211500	MERCEDES-BENZ
-------------	---------------
