



# BRAKE PAD PRIME CERAMIC P59080N

The P59080N NAO brake pad is synonymous with reliability

Brembo NAO brake pads stand out for their ultimate braking comfort, reduced friction wear and low dust mission, which makes for cleaner rims and reduced maintenance requirements. The advanced friction material in keeping with the strictest environmental standards is the main distinguishing feature of NAO compounds.

- ✓ OE-equivalent
- ✓ Brembo quality
- ✓ Safety
- ✓ Comfort
- ✓ Durability
- ✓ Dust reduction
- ✓ With accessories



## Technical specifications

EAN code <b>8020584081426</b>	Axle <b>Rear</b>	Thickness <b>16 mm</b>
Width <b>117 mm</b>	Height <b>43 mm</b>	Braking system <b>TRW</b>
Wear indicator <b>Acoustic</b>	WVA number <b>25098,25096,25097</b>	Accessories <b>With anti-squeal shim</b>

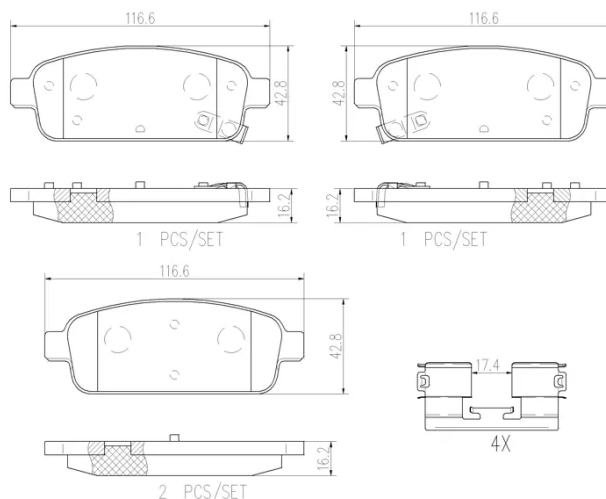

COMPATIBLE VEHICLES

## COMPATIBLE OE PART NUMBERS

13408579	BUICK
42518441	BUICK
133192294	CHEVROLET
13404405	CHEVROLET
13411380	CHEVROLET
13411383	CHEVROLET
20918873	CHEVROLET
42793717	CHEVROLET
42793718	CHEVROLET
13300868	GENERAL MOTORS
0542039	OPEL
0542040	OPEL
13300867	OPEL
13319293	OPEL
13319294	OPEL
13411380	OPEL
13411383	OPEL
13473427	OPEL
13473428	OPEL
1605140	OPEL
1605168	OPEL
1605176	OPEL
1605180	OPEL
1605262	OPEL
1605294	OPEL
1605296	OPEL
542039	OPEL
542040	OPEL
95516192	OPEL
95530021	OPEL
95530022	OPEL
13300867	VAUXHALL
13319293	VAUXHALL
13411380	VAUXHALL
1605140	VAUXHALL
1605168	VAUXHALL
1605176	VAUXHALL
95530021	VAUXHALL
95530022	VAUXHALL