



BRAKE PAD PRIME CERAMIC P86018N

The P86018N NAO brake pad is synonymous with reliability

Brembo NAO brake pads stand out for their ultimate braking comfort, reduced friction wear and low dust mission, which makes for cleaner rims and reduced maintenance requirements. The advanced friction material in keeping with the strictest environmental standards is the main distinguishing feature of NAO compounds.

- ✓ OE-equivalent
- ✓ Brembo quality
- ✓ Safety
- ✓ Comfort
- ✓ Durability
- ✓ Dust reduction
- ✓ With accessories



Technical specifications

EAN code 8020584080344	Axle Front	Thickness 20 mm
Width 155 mm	Height 75 mm	Braking system Teves
Wear indicator Without	WVA number 24141,24142	Accessories With accessories With anti-squeal shim With piston clip

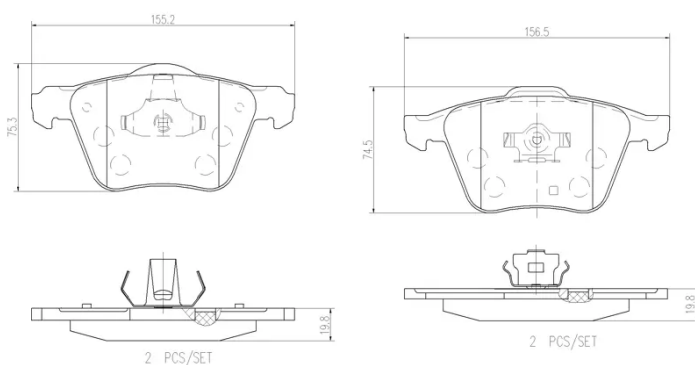

COMPATIBLE VEHICLES

COMPATIBLE OE PART NUMBERS

274331	VOLVO
--------	-------

2743318	VOLVO
---------	-------

30769125	VOLVO
----------	-------

31201839	VOLVO
----------	-------

31262705	VOLVO
----------	-------

312627050	VOLVO
-----------	-------

316871010	VOLVO
-----------	-------