



BRAKE PAD

P 30 109

The P 30 109 brake pad is synonymous with reliability

The Brembo brake pad guarantees ultimate safety when braking thanks to the use of more than 100 different compounds, designed according to the type of vehicle and use. Stopping distances reduced to a minimum, maximum driving comfort and silent operation are the most important features of Brembo materials. Brembo brake pads are supplied together with an extensive range of accessories and assembly kits for professional-standard installation.

- ✓ OE-equivalent
- ✓ Brembo quality
- ✓ ECE-R90 certificate
- ✓ Safety
- ✓ Performance
- ✓ Comfort
- ✓ With accessories



Technical specifications

EAN code 8020584115077	Axle Rear	Thickness 16 mm
Width 105 mm	Height 49 mm	
Wear indicator Acoustic	WVA number 22676,22677,22675	Accessories With accessories With anti-squeal shim With piston clip

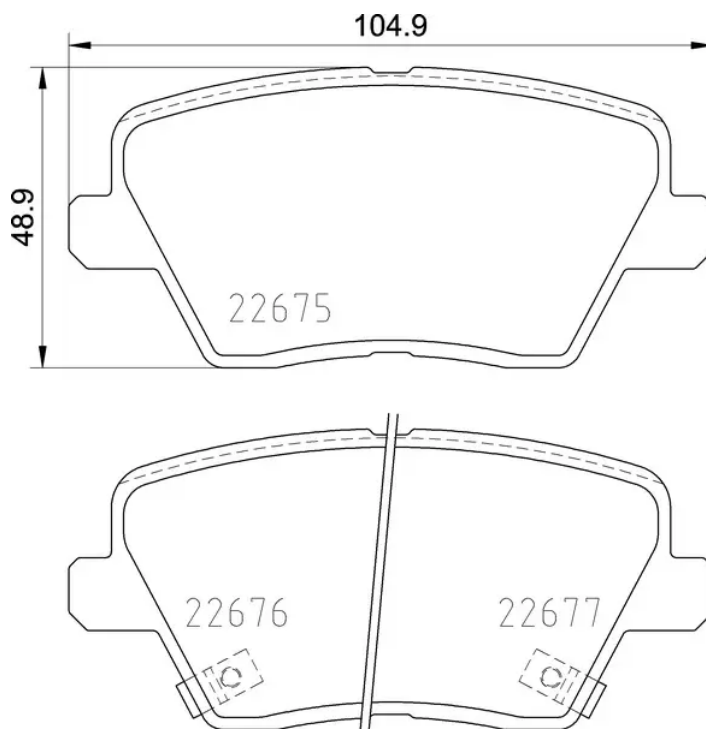



COMPATIBLE OE PART NUMBERS

58302G4A30

HYUNDAI
