



# LA BRAKE PAD 07BB19LA

The 07BB19LA brake pad is synonymous with reliability

sintered compound, specifically for front-wheel applications, characterised by good performance and stability paired with excellent durability

- ✓ OE-equivalent
- ✓ Brembo quality
- ✓ ECE-R90 certificate
- ✓ Safety
- ✓ Performance
- ✓ Comfort
- ✓ Durability



## Technical specifications

Width mm	Height <b>55,5</b> mm	Thickness <b>8,6</b> mm
Compound <b>Sinter</b>	Units per box <b>2</b>	

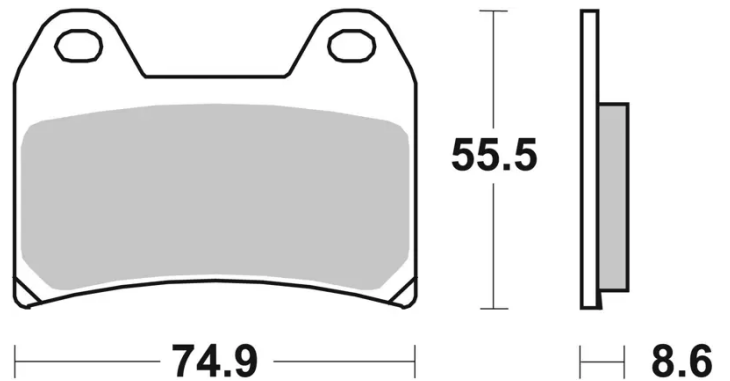

COMPATIBLE VEHICLES