



BRAKE PAD NAO P85144N

The P85144N NAO brake pad is synonymous with reliability

Brembo NAO brake pads stand out for their ultimate braking comfort, reduced friction wear and low dust mission, which makes for cleaner rims and reduced maintenance requirements. The advanced friction material in keeping with the strictest environmental standards is the main distinguishing feature of NAO compounds.

- ✓ OE-equivalent
- ✓ Brembo quality
- ✓ Safety
- ✓ Comfort
- ✓ Durability
- ✓ Dust reduction
- ✓ With accessories



Technical specifications

EAN code
8020584068175

Axle
Front

Thickness
20 mm

Width
175 mm

Height
70 mm

Braking system
TRW

Wear indicator
Electric

WVA number
25217,24738

Accessories
With accessories
With anti-squeal shim
With brake caliper bolts

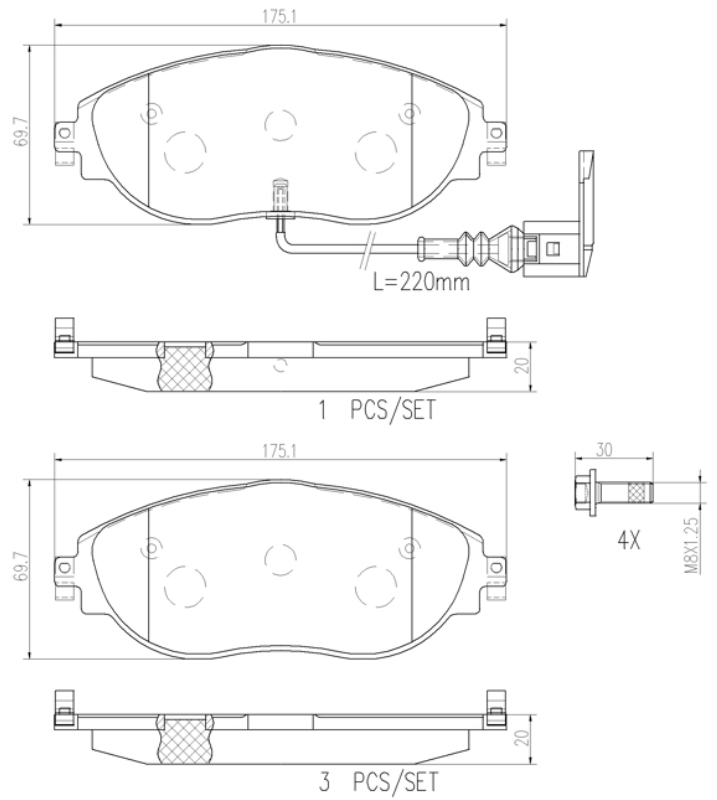

COMPATIBLE VEHICLES

COMPATIBLE OE PART NUMBERS

3Q0698151B	AUDI
5Q0698151K	AUDI
8V0698151C	AUDI
JZW698151AT	AUDI
3Q0698151B	SEAT
5Q0698151K	SEAT
8V0698151C	SEAT
JZW698151AT	SEAT
3Q0698151B	SKODA
5Q0698151AJ	SKODA
5Q0698151K	SKODA
8V0698151C	SKODA
JZW698151AT	SKODA
3Q0698151B	VW
5Q0698151AG	VW
5Q0698151K	VW
8V0698151C	VW
JZW698151AT	VW
JZW698302DG	VW