



BRAKE DISC PAINTED

09.6924.11

The 09.6924.11 painted brake disc is synonymous with reliability

The Brembo brake disc with special UV paint treatment guarantees superior corrosion resistance for the product, thanks to the protective coating on the outer edges and on the disc hub. The UV paint not only gives the disc a clean, shiny appearance but is also beneficial for the environment as the water-based UV paint treatment does not require the use of chemical solvents and is a low energy consumption process.

- ✓ OE-equivalent
- ✓ Brembo quality
- ✓ ECE-R90 certificate
- ✓ Safety
- ✓ High carbon
- ✓ Anti-corrosion
- ✓ Fastening screws



Technical specifications

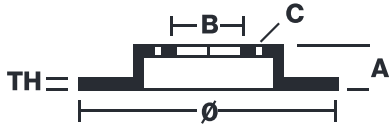

EAN code	Axle	Diameter Ø
8020584013762	Front	296 mm
Thickness (TH)	Height (A)	Number of holes (C)
22 mm	76 mm	5
Brake disc type	Centering (B)	Min. thickness
Ventilated	79 mm	20,4 mm

Tightening torque
120 Nm

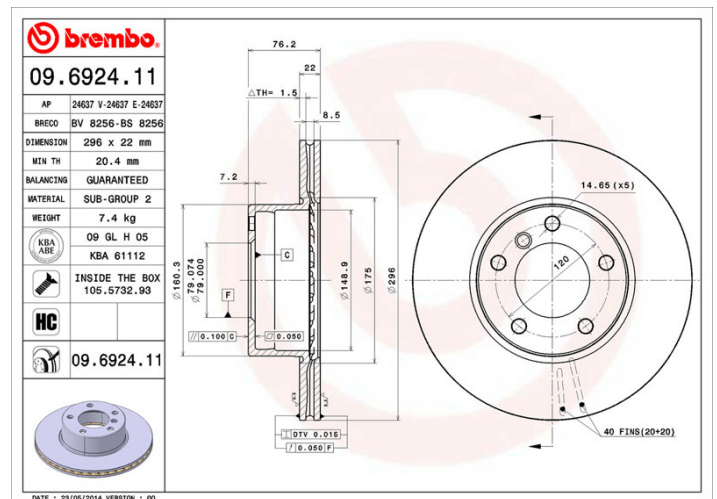

COMPATIBLE VEHICLES

COMPATIBLE OE PART NUMBERS

34111163013 BMW

34111163081 BMW

34111164839 BMW

34116767061 BMW
