



BRAKE PAD NAO P16013N

The P16013N NAO brake pad is synonymous with reliability

Brembo NAO brake pads stand out for their ultimate braking comfort, reduced friction wear and low dust mission, which makes for cleaner rims and reduced maintenance requirements. The advanced friction material in keeping with the strictest environmental standards is the main distinguishing feature of NAO compounds.

- ✓ OE-equivalent
- ✓ Brembo quality
- ✓ Safety
- ✓ Comfort
- ✓ Durability
- ✓ Dust reduction
- ✓ With accessories



Technical specifications

EAN code 8020584083727	Axle Front and rear	Thickness 15 mm
Width 126 mm	Height 52 mm	Braking system Lucas
Wear indicator Acoustic	WVA number 24284,24285,24283	Accessories With accessories With anti-squeal shim

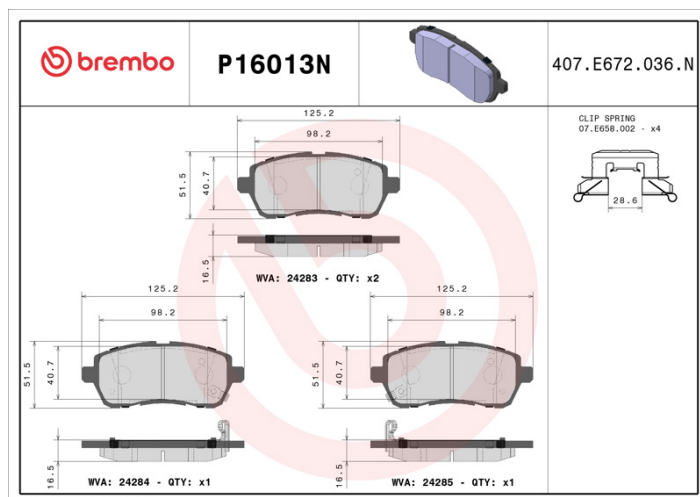

COMPATIBLE VEHICLES

COMPATIBLE OE PART NUMBERS

3501180BE01	CHANGAN
3501280BE01	CHANGAN
04465B1120000	DAIHATSU
04465B1190	DAIHATSU
04465B1190000	DAIHATSU
04465B1191	DAIHATSU
04465B1191000	DAIHATSU
04465B1320	DAIHATSU
04465B1320000	DAIHATSU
04465B1380	DAIHATSU
04491B1120	DAIHATSU
04491B1121	DAIHATSU
04491B1190	DAIHATSU
4491B1121	DAIHATSU
DA1H3328Z	DAIHATSU
BV6Z2V200A	FORD
DGY03328Z	FORD
BV612M007B4B	FORD (CHANGAN)
DA1H3328Z	FORD (CHANGAN)
DGY03328Z	FORD (CHANGAN)
DGY13328Z	FORD (CHANGAN)
45022TS6H50	HONDA (DONGFENG)
D0YN3328ZA	MAZDA
D0YN3328ZB	MAZDA
DFY13328Z	MAZDA
DFY13328ZA	MAZDA
DFY13328ZA9C	MAZDA
DGY13328Z	MAZDA (CHANGAN)
04465B1120	MITSUBISHI
DFY13328Z	MITSUBISHI
55810B58M50N000	PROTON
5581052R20	SUZUKI
5581052R20000	SUZUKI
5581052R21	SUZUKI
5581052R50	SUZUKI
5581052R50000	SUZUKI
5581052R51	SUZUKI
5581052R51000	SUZUKI
5581068L00	SUZUKI
5581068L00000	SUZUKI
5581068L50	SUZUKI
5581068L50000	SUZUKI
5581068R00	SUZUKI
5581068R00000	SUZUKI
5581068R01	SUZUKI

5581068R10	SUZUKI
5581068R10000	SUZUKI
5581069P00	SUZUKI
5581071LS1	SUZUKI
5581071LS1000	SUZUKI
5581071LS2	SUZUKI
55810B58M50N	SUZUKI
55810M60M00	SUZUKI
55810M69P00	SUZUKI
55810M69P50	SUZUKI