



BRAKE PAD NAO P54026N

The P54026N NAO brake pad is synonymous with reliability

Brembo NAO brake pads stand out for their ultimate braking comfort, reduced friction wear and low dust mission, which makes for cleaner rims and reduced maintenance requirements. The advanced friction material in keeping with the strictest environmental standards is the main distinguishing feature of NAO compounds.

- ✓ OE-equivalent
- ✓ Brembo quality
- ✓ Safety
- ✓ Comfort
- ✓ Durability
- ✓ Dust reduction
- ✓ With accessories

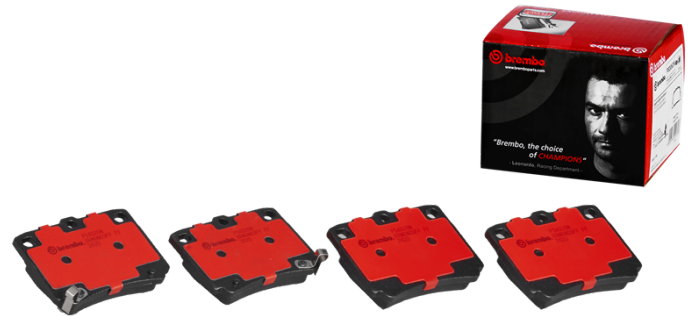

Technical specifications

EAN code 8020584084977	Axle Rear	Thickness 15 mm
Width 79 mm	Height 59 mm	Braking system Sumitomo
Wear indicator Acoustic	WVA number 23593,23594,23595	Accessories With anti-squeal shim

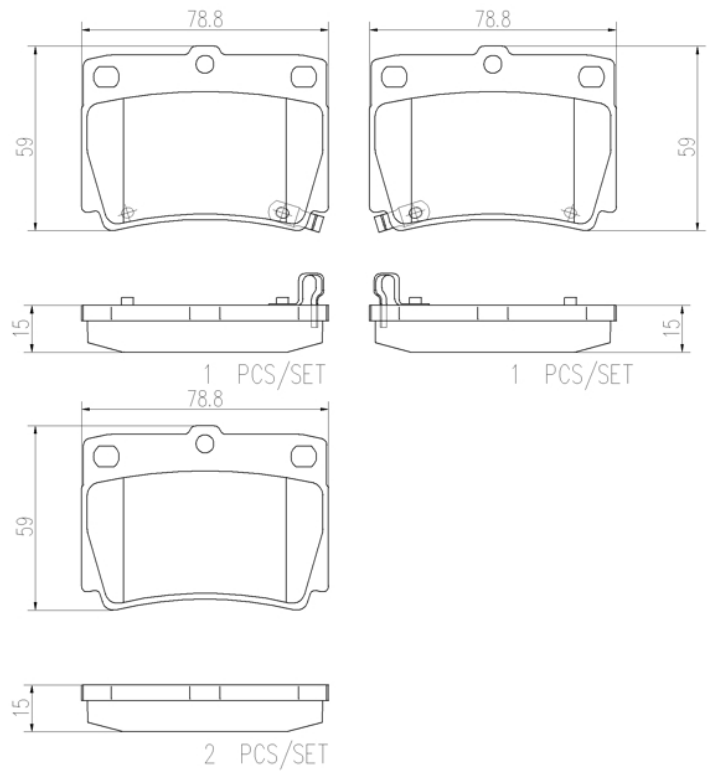

COMPATIBLE VEHICLES

COMPATIBLE OE PART NUMBERS

4605A783	mitsubishi
4605B291	mitsubishi
MN102626	mitsubishi
MR307415	mitsubishi
MR389575	mitsubishi
MZ690027	mitsubishi
MZ690047	mitsubishi
4605B291	mitsubishi (GAC)