



BRAKE PAD NAO P23154N

The P23154N NAO brake pad is synonymous with reliability

Brembo NAO brake pads stand out for their ultimate braking comfort, reduced friction wear and low dust mission, which makes for cleaner rims and reduced maintenance requirements. The advanced friction material in keeping with the strictest environmental standards is the main distinguishing feature of NAO compounds.

- ✓ OE-equivalent
- ✓ Brembo quality
- ✓ Safety
- ✓ Comfort
- ✓ Durability
- ✓ Dust reduction
- ✓ With accessories

Technical specifications

EAN code 8020584121382	Axle Front	Thickness 16 mm
Width 132 mm	Height 77 mm	Braking system Brembo
Wear indicator Electric	WVA number 23756,23092,23757	Accessories With anti-squeal shim

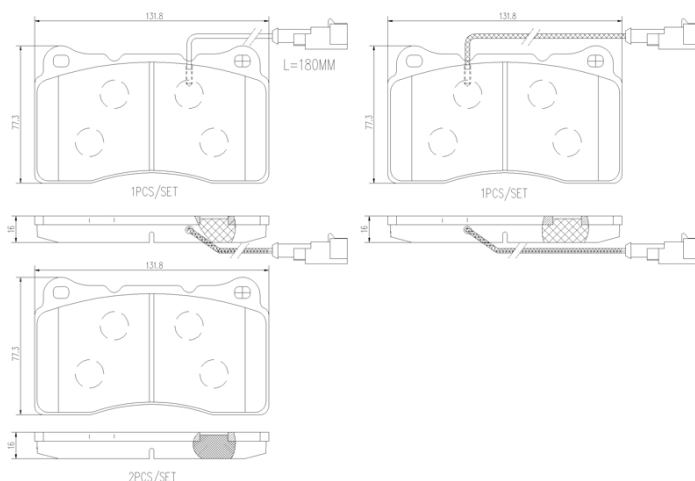

COMPATIBLE VEHICLES

COMPATIBLE OE PART NUMBERS