



BRAKE PAD PRIME CERAMIC P49064N

The P49064N NAO brake pad is synonymous with reliability

Brembo NAO brake pads stand out for their ultimate braking comfort, reduced friction wear and low dust mission, which makes for cleaner rims and reduced maintenance requirements. The advanced friction material in keeping with the strictest environmental standards is the main distinguishing feature of NAO compounds.

- ✓ OE-equivalent
- ✓ Brembo quality
- ✓ Safety
- ✓ Comfort
- ✓ Durability
- ✓ Dust reduction
- ✓ With accessories

Technical specifications

EAN code 8020584119372	Axle Rear	Thickness 14 mm
Width 123 mm	Height 44 mm	Braking system Teves
Wear indicator Acoustic	WVA number 26175,26176,26174	Accessories With anti-squeal shim

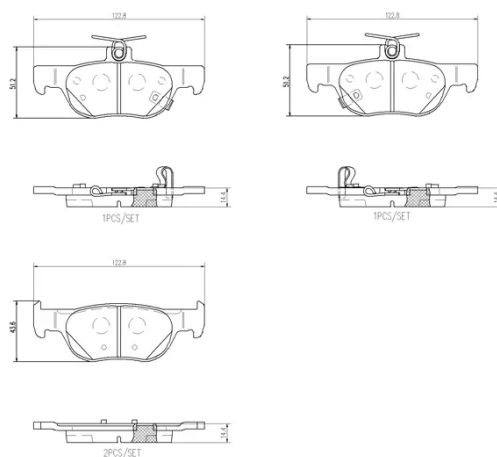

COMPATIBLE VEHICLES

COMPATIBLE OE PART NUMBERS

BCYA2643Z	MAZDA
BCYA2643ZA	MAZDA
BCYA2643ZB	MAZDA
BDYS2643Z	MAZDA
BDYS2643ZA	MAZDA
DFZ52643Z	MAZDA
DFZ52643ZA	MAZDA
DFZ52643ZB	MAZDA
DGY62643Z	MAZDA
DAYF2643ZA	MAZDA (CHANGAN)