



SPORT | HP2 BRAKE PADS

07.B315.83

The **07.B315.83** brake pad is synonymous with reliability

HP2 brake pads offer outstanding cold performance a good bite, superior fading resistance, and friction stability in all conditions and low dust levels. Thanks to the friction material, they provide significant advantages over their competitors. Designed to be interchangeable with original equipment brake pads (OE), they are approved to ECE-R90.

- ✓ OE-equivalent
- ✓ Brembo quality
- ✓ ECE-R90 certificate
- ✓ Safety
- ✓ Performance
- ✓ Comfort
- ✓ Sports driving
- ✓ Sporty look



Technical specifications

Width **140 mm** Thickness **18 mm**

WVA number **25196,25197,25198** Axle **Rear**

EAN code **8020584604113**

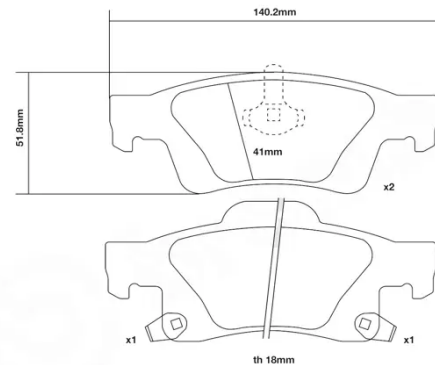

COMPATIBLE VEHICLES