



LA BRAKE PAD 07BB19LA

The 07BB19LA brake pad is synonymous with reliability

sintered compound, specifically for front-wheel applications, characterised by good performance and stability paired with excellent durability

- ✓ OE-equivalent
- ✓ Brembo quality
- ✓ ECE-R90 certificate
- ✓ Safety
- ✓ Performance
- ✓ Comfort
- ✓ Durability



Technical specifications

Width mm	Height 55,5 mm	Thickness 8,6 mm
Compound Sinter	Units per box 2	

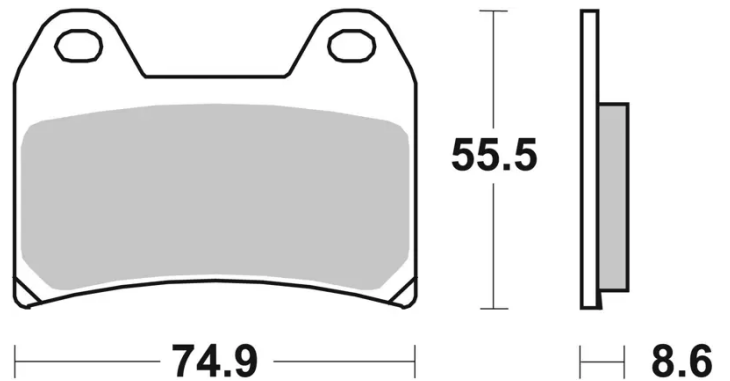

COMPATIBLE VEHICLES