



BRAKE PAD

P 54 039

The P 54 039 brake pad is synonymous with reliability

The Brembo brake pad guarantees ultimate safety when braking thanks to the use of more than 100 different compounds, designed according to the type of vehicle and use. Stopping distances reduced to a minimum, maximum driving comfort and silent operation are the most important features of Brembo materials. Brembo brake pads are supplied together with an extensive range of accessories and assembly kits for professional-standard installation.

- ✓ OE-equivalent
- ✓ Brembo quality
- ✓ ECE-R90 certificate
- ✓ Safety
- ✓ Performance
- ✓ Comfort



Technical specifications

EAN code	Axle	Thickness
8020584061329	Front	15 mm
Width	Height	Braking system
132 mm	77 mm	Brembo
Wear indicator	WVA number	
Acoustic	23092,23325	

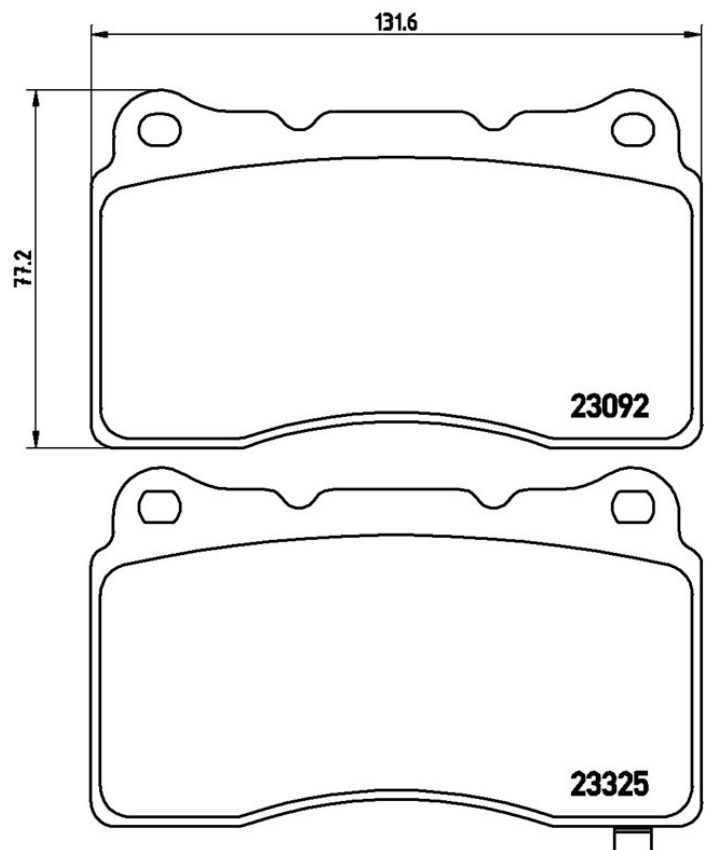

COMPATIBLE OE PART NUMBERS

45022TV8E02	HONDA
26296FE040	MITSUBISHI
26296FE041	MITSUBISHI
4605A049	MITSUBISHI
4605A572	MITSUBISHI
4605A694	MITSUBISHI
MR407376	MITSUBISHI
MR407377	MITSUBISHI
26296FE010	SUBARU
26296FE040	SUBARU
26296FE041	SUBARU
26296FE042	SUBARU
26296FE100	SUBARU
26296FE120	SUBARU
SU00307217	TOYOTA