



BRAKE PAD

P 09 032

The P 09 032 brake pad is synonymous with reliability

The Brembo brake pad guarantees ultimate safety when braking thanks to the use of more than 100 different compounds, designed according to the type of vehicle and use. Stopping distances reduced to a minimum, maximum driving comfort and silent operation are the most important features of Brembo materials. Brembo brake pads are supplied together with an extensive range of accessories and assembly kits for professional-standard installation.

- ✓ OE-equivalent
- ✓ Brembo quality
- ✓ ECE-R90 certificate
- ✓ Safety
- ✓ Performance
- ✓ Comfort



Technical specifications

EAN code 8020584122808	Axle Rear	Thickness 16 mm
Width 127 mm	Height 53 mm	Braking system Mando
Wear indicator Acoustic	WVA number 26496,26497,26498	

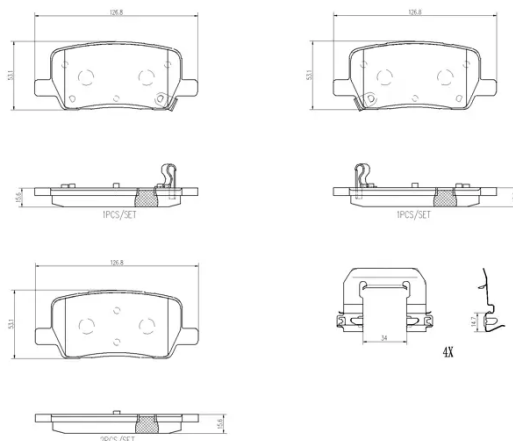

COMPATIBLE VEHICLES

COMPATIBLE OE PART NUMBERS

100767800A	TESLA
------------	-------

109741600A	TESLA
------------	-------

109741600B	TESLA
------------	-------

109741600C	TESLA
------------	-------

109767800A	TESLA
------------	-------

1551216400	TESLA
------------	-------
