



BRAKE PAD XTRA

P 24 148X

The P 24 148X Xtra brake pad is synonymous with reliability

Brembo Xtra brake pads, developed to enhance the advantages of the Xtra and Max discs, are made using the special BRM X L01 compound which consists of more than 30 different components. Compared with the compound used for original-equivalent pads, the new solution assures a higher friction coefficient, which translates to more precise and stable braking, at both high and low temperatures. All this makes for greater driving comfort and improved pedal modularity, without compromising the product's mileage output.



- ✓ OE-equivalent
- ✓ Brembo quality
- ✓ ECE-R90 certificate
- ✓ Safety
- ✓ Performance
- ✓ Sports driving

Technical specifications

EAN code	Axle	Thickness
8020584068809	Rear	16 mm
Width	Height	Braking system
123 mm	52 mm	Teves
Wear indicator	WVA number	
Without	25213,25212	

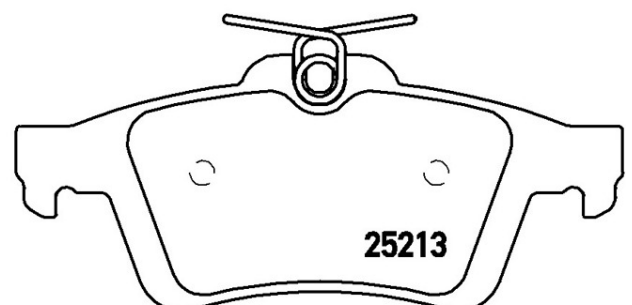
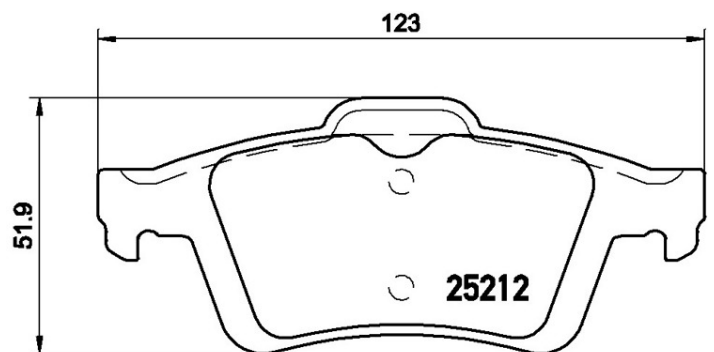

COMPATIBLE OE PART NUMBERS

1683374	FORD
1765765	FORD
1805813	FORD
1809458	FORD
1820122	FORD
2039739	FORD
2252494	FORD
2271380	FORD
5134101	FORD
AV612M008AA	FORD
AV612M008AB	FORD
AV612M008BA	FORD
BV612M007BA	FORD
BV612M007CB	FORD
G2MJ2C453CCB	FORD
GN152M007AA	FORD
KTKV6C2M008AA	FORD
KTKV6C2M008AB	FORD
MEAV6J2M008BA	FORD
MEAV6J2M008CA	FORD
MEMV6J2M008A2A	FORD
1841463	FORD (CHANGAN)
BV612M007B3A	FORD (CHANGAN)
BV612M007B4A	FORD (CHANGAN)
BV6Z2200D	FORD (CHANGAN)
AV6Z2200A	FORD ASIA & OCEANIA
AV6Z2200B	FORD ASIA & OCEANIA
FU2Z2V200C	FORD USA
FU2Z2V200F	FORD USA
GN1Z2200B	FORD USA
GN1Z2200E	FORD USA
44060HA00B	NISSAN
44060HA00C	NISSAN
30742031	VOLVO
31323501	VOLVO
31341327	VOLVO
31341331	VOLVO