



SPORT | TY3 BRAKE DISC

59.E114.67

The 59.E114.67 brake disc is synonymous with reliability

Type-3 slotting used to distinguish the Brembo SPORT | TY3 brake disc is widely used in professional motorsports. It therefore offers superior initial response with excellent release characteristics, improving braking performance while giving the vehicle an aggressive appearance. The Brembo logo on the braking surface adds an exclusive and unique touch to the vehicle. The SPORT | TY3 brake discs are plug-and-play since they replace OE discs directly.



- ✓ OE-equivalent
- ✓ Brembo quality
- ✓ ECE-R90 certificate
- ✓ Safety
- ✓ Performance
- ✓ Comfort
- ✓ Sports driving
- ✓ Sparty look

Technical specifications

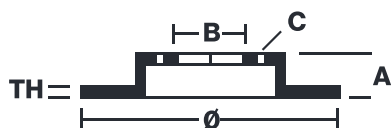

Diameter	Thickness (TH)	Height (A)
282 mm	12 mm	48 mm
Number of holes (C)	Brake disc type	Centering
5	Solid	65 mm
Min. thickness	Tightening torque	Axle
10 mm	120 Nm	Rear
Units per box	EAN code	
0	8020584605400	

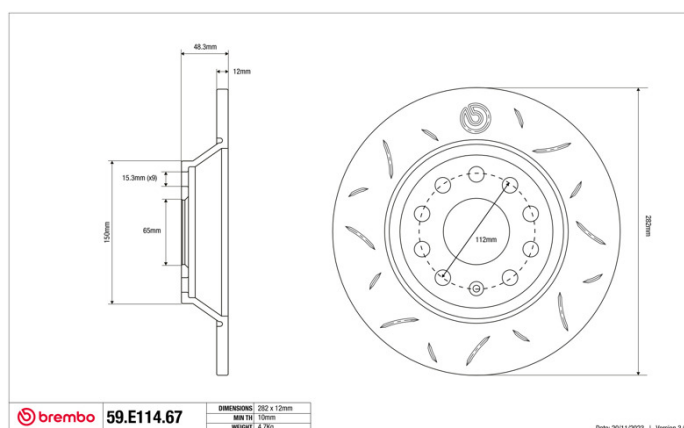

59.E114.67	DIMENSIONS: 282 x 12mm
	MIN TH: 10mm
	WEIGHT: 4.7kg

Date: 2011/2023 | Version: 3.00

