



BRAKE DISC PAINTED

09.D528.13

Co-Cast brake disc 09.D528.13 belongs to Brembo Premium Line

The Co-Cast brake disc consists of a steel hat cast onto the high-carbon cast iron braking surface. This technology not only ensures superior performance for the braking system but also allows the weight of the disc itself to be reduced by up to 15%, resulting in reduced consumption and emission levels and improved road handling.



- ✓ OE-equivalent
- ✓ Brembo quality
- ✓ ECE-R90 certificate
- ✓ Weight reduction
- ✓ High carbon
- ✓ Bi-Material Brake Disc
- ✓ Anti-corrosion
- ✓ PVT ventilation
- ✓ Fastening screws
- ✓ Fading resistance

Technical specifications

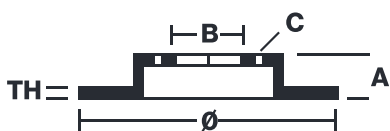

EAN code
8020584232491

Axle
Front

Diameter Ø
330 mm

Thickness (TH)
32 mm

Height (A)
63 mm

Number of holes (C)
5

Brake disc type
Ventilated

Centering (B)
69 mm

Min. thickness
29,4 mm

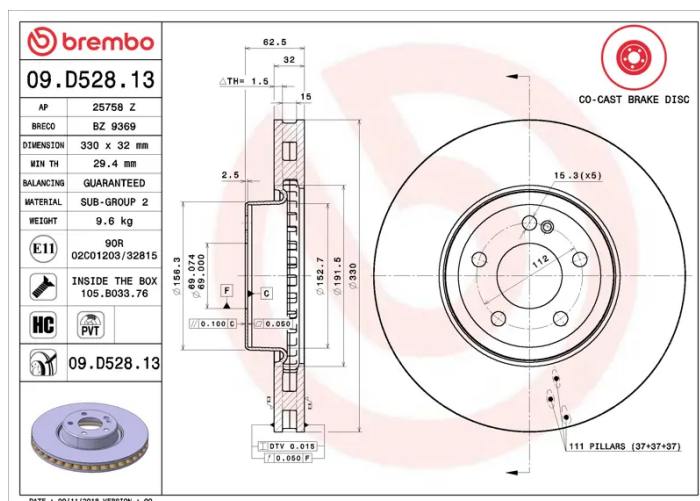

COMPATIBLE OE PART NUMBERS

0004212712	MERCEDES-BENZ
A0004212712	MERCEDES-BENZ
A0004212712	MERCEDES-BENZ (BBDC)