



BRAKE PAD PRIME CERAMIC P24217N

The P24217N NAO brake pad is synonymous with reliability

Brembo NAO brake pads stand out for their ultimate braking comfort, reduced friction wear and low dust mission, which makes for cleaner rims and reduced maintenance requirements. The advanced friction material in keeping with the strictest environmental standards is the main distinguishing feature of NAO compounds.

- ✓ OE-equivalent
- ✓ Brembo quality
- ✓ Safety
- ✓ Comfort
- ✓ Durability
- ✓ Dust reduction
- ✓ With accessories

Technical specifications

EAN code 8020584117545	Axle Rear	Thickness 14 mm
Width 123 mm	Height 48 mm	Braking system ATE
Wear indicator Acoustic	WVA number 22231,22232,22233	Accessories With anti-squeal shim

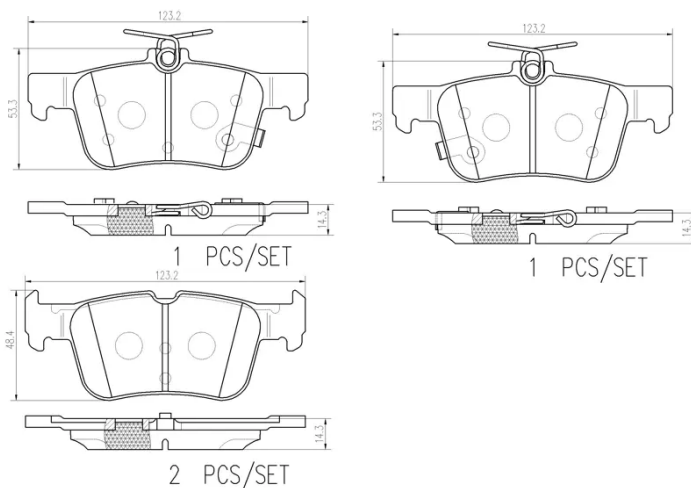

COMPATIBLE VEHICLES

COMPATIBLE OE PART NUMBERS

2209329 FORD

2247444 FORD

2367295 FORD

2379248 FORD

2433333 FORD

2493719 FORD

2494035 FORD

BRF1954 FORD

JX6Z2200E FORD

KTJ1GC2M007AC FORD

KTJX612M007ACC FORD

KTJX612M007AEB FORD

KTJX612M007AEC FORD

KTJX612M007AED FORD

KTJX6612M007AED FORD

KTLX612M007BEA FORD
