



# BRAKE PAD

## P 49 064

The P 49 064 brake pad is synonymous with reliability

The Brembo brake pad guarantees ultimate safety when braking thanks to the use of more than 100 different compounds, designed according to the type of vehicle and use. Stopping distances reduced to a minimum, maximum driving comfort and silent operation are the most important features of Brembo materials. Brembo brake pads are supplied together with an extensive range of accessories and assembly kits for professional-standard installation.

- ✓ OE-equivalent
- ✓ Brembo quality
- ✓ ECE-R90 certificate
- ✓ Safety
- ✓ Performance
- ✓ Comfort



### Technical specifications

EAN code <b>8020584117958</b>	Axle <b>Rear</b>	Thickness <b>14 mm</b>
Width <b>123 mm</b>	Height <b>44 mm</b>	Braking system <b>Teves</b>
Wear indicator <b>Acoustic</b>	WVA number <b>26175,26174,26176</b>	Accessories <b>With anti-squeal shim</b>

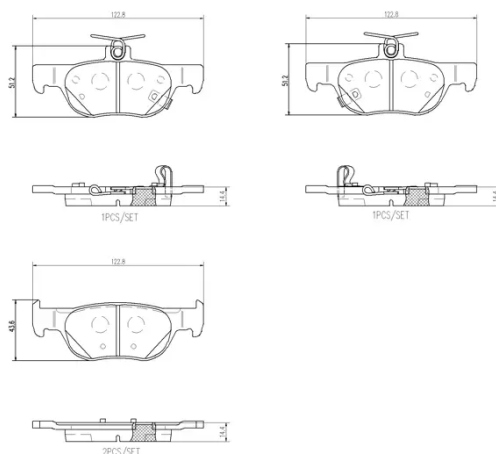

COMPATIBLE VEHICLES

## COMPATIBLE OE PART NUMBERS

BCYA2643Z	MAZDA
BCYA2643ZA	MAZDA
BCYA2643ZB	MAZDA
BDYS2643Z	MAZDA
BDYS2643ZA	MAZDA
DFZ52643Z	MAZDA
DFZ52643ZA	MAZDA
DFZ52643ZB	MAZDA
DGY62643Z	MAZDA
DAYF2643ZA	MAZDA (CHANGAN)