



BRAKE DISC PAINTED

09.8875.31

The 09.8875.31 painted brake disc is synonymous with reliability

The Brembo brake disc with special UV paint treatment guarantees superior corrosion resistance for the product, thanks to the protective coating on the outer edges and on the disc hub. The UV paint not only gives the disc a clean, shiny appearance but is also beneficial for the environment as the water-based UV paint treatment does not require the use of chemical solvents and is a low energy consumption process.

- ✓ OE-equivalent
- ✓ Brembo quality
- ✓ ECE-R90 certificate
- ✓ Safety
- ✓ High carbon
- ✓ Anti-corrosion



Technical specifications

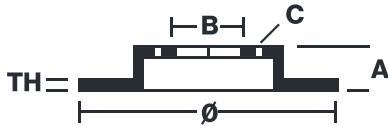

EAN code 8020584017234	Axle Front	Diameter Ø 337 mm
Thickness (TH) 30 mm	Height (A) 62 mm	Number of holes (C) 5
Brake disc type Ventilated	Centering (B) 79 mm	Min. thickness 27 mm

Tightening torque
140 Nm

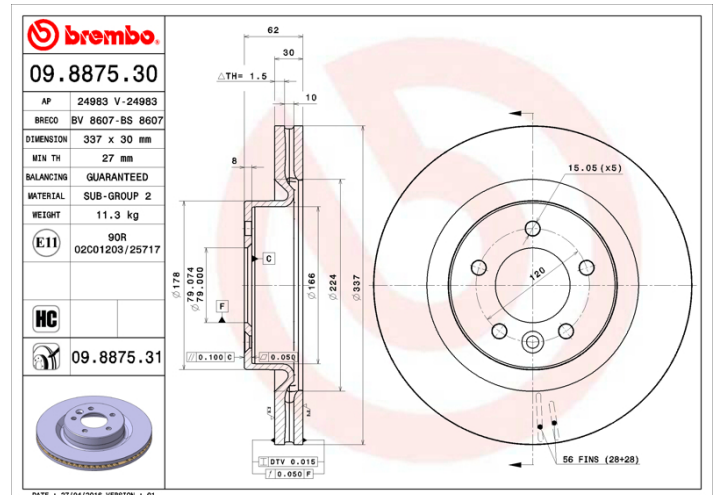

COMPATIBLE VEHICLES

COMPATIBLE OE PART NUMBERS

SDB000611	LAND ROVER
-----------	------------

SDB000612	LAND ROVER
-----------	------------

SDB000613	LAND ROVER
-----------	------------

SDB000614	LAND ROVER
-----------	------------

SDB500130	LAND ROVER
-----------	------------
