



BRAKE PAD NAO P28047N

The P28047N NAO brake pad is synonymous with reliability

Brembo NAO brake pads stand out for their ultimate braking comfort, reduced friction wear and low dust mission, which makes for cleaner rims and reduced maintenance requirements. The advanced friction material in keeping with the strictest environmental standards is the main distinguishing feature of NAO compounds.

- ✓ OE-equivalent
- ✓ Brembo quality
- ✓ Safety
- ✓ Comfort
- ✓ Durability
- ✓ Dust reduction
- ✓ With accessories



Technical specifications

EAN code 8020584097731	Axle Front	Thickness 17 mm
Width 149 mm	Height 60 mm	Braking system Sumitomo
Wear indicator Acoustic	WVA number 24053,24054,24055	Accessories With anti-squeal shim

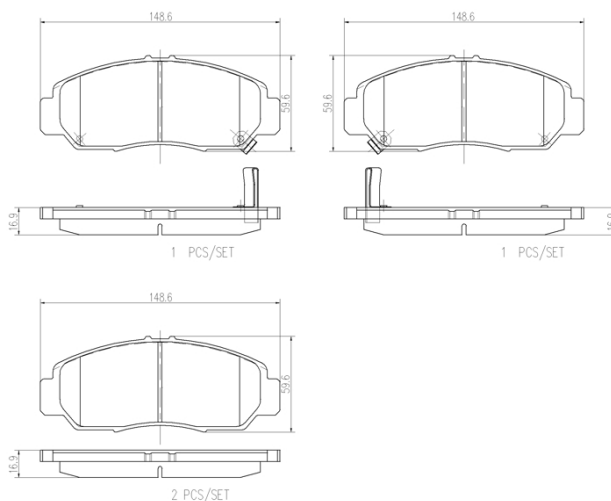

COMPATIBLE VEHICLES

COMPATIBLE OE PART NUMBERS

06450S7AE00	HONDA
06450S7AE50	HONDA
06450SJFE00	HONDA
45022SDAC00	HONDA
45022SDBA00	HONDA
45022SDBA10	HONDA
45022SDBA11	HONDA
45022SDDA10	HONDA
45022SDRA10	HONDA
45022SDRA11	HONDA
45022SMA010	HONDA
45022TSAK00	HONDA
45022TP5H00	HONDA (DONGFENG)