



BRAKE DISC PAINTED

09.D899.13

Composite brake disc 09.D899.13 belongs to Brembo Premium Line

The Composite brake disc is dedicated to the highest-performance BMW applications and is perfectly interchangeable with the original disc. It has an aluminium hat connected to the special cast iron braking surface by steel pins. This solution makes the disc lighter for improved handling of the car.



- ✓ OE-equivalent
- ✓ Brembo quality
- ✓ ECE-R90 certificate
- ✓ Weight reduction
- ✓ High carbon
- ✓ Bi-Material Brake Disc
- ✓ Anti-corrosion
- ✓ Fastening screws
- ✓ Fading resistance

Technical specifications

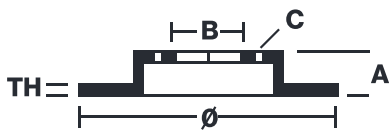

EAN code
8020584238301

Axle
Front left

Diameter Ø
395 mm

Thickness (TH)
36 mm

Height (A)
62 mm

Number of holes (C)
5

Brake disc type
Ventilated

Centering (B)
75 mm

Min. thickness
34,4 mm

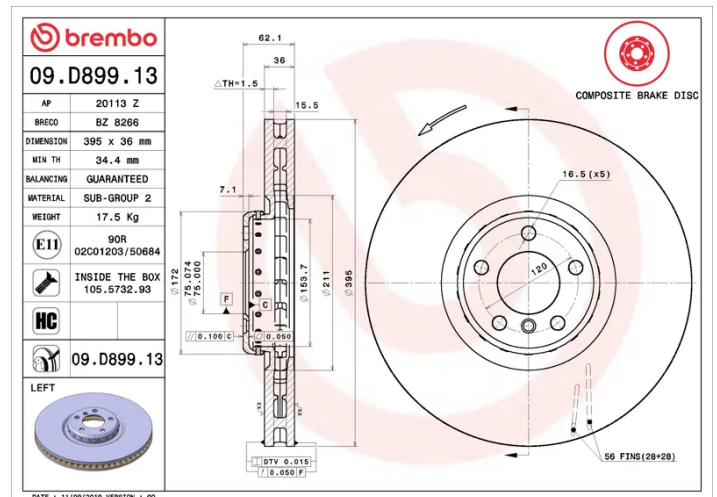

COMPATIBLE VEHICLES

COMPATIBLE OE PART NUMBERS

34116789069 BMW

34116898727 BMW