



# BRAKE PAD PRIME CERAMIC P59096N

The P59096N NAO brake pad is synonymous with reliability

Brembo NAO brake pads stand out for their ultimate braking comfort, reduced friction wear and low dust mission, which makes for cleaner rims and reduced maintenance requirements. The advanced friction material in keeping with the strictest environmental standards is the main distinguishing feature of NAO compounds.

- ✓ OE-equivalent
- ✓ Brembo quality
- ✓ Safety
- ✓ Comfort
- ✓ Durability
- ✓ Dust reduction
- ✓ With accessories

## Technical specifications

EAN code <b>8020584119662</b>	Axle <b>Front</b>	Thickness <b>20 mm</b>
Width <b>142 mm</b>	Height <b>62 mm</b>	Braking system <b>Akebono</b>
Wear indicator <b>Acoustic</b>	WVA number <b>22840,22839,22838</b>	Accessories <b>With anti-squeal shim</b>

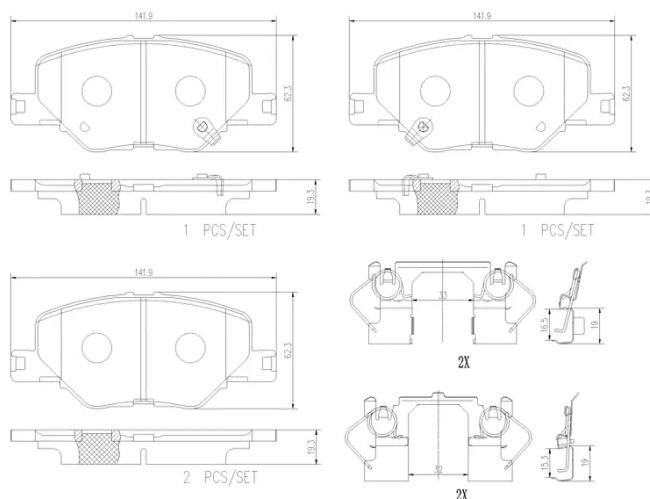

COMPATIBLE VEHICLES

## COMPATIBLE OE PART NUMBERS

84124408	OPEL
84124408	VAUXHALL