



BRAKE PAD

P 23 154

The P 23 154 brake pad is synonymous with reliability

The Brembo brake pad guarantees ultimate safety when braking thanks to the use of more than 100 different compounds, designed according to the type of vehicle and use. Stopping distances reduced to a minimum, maximum driving comfort and silent operation are the most important features of Brembo materials. Brembo brake pads are supplied together with an extensive range of accessories and assembly kits for professional-standard installation.

- ✓ OE-equivalent
- ✓ Brembo quality
- ✓ ECE-R90 certificate
- ✓ Safety
- ✓ Performance
- ✓ Comfort



Technical specifications

EAN code
8020584110010

Axle
Front

Thickness
16 mm

Width
132 mm

Height
77 mm

Braking system
Brembo

Wear indicator
Electric

WVA number
23756,23757,23092

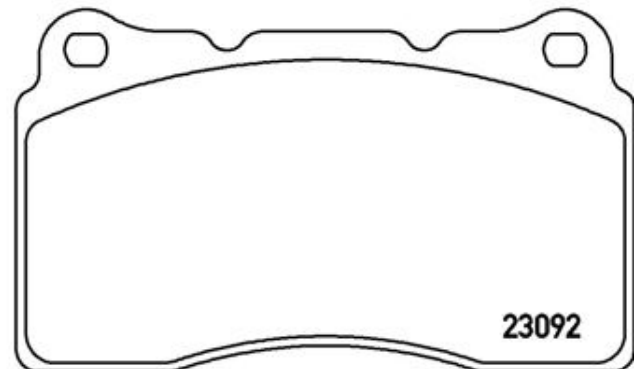
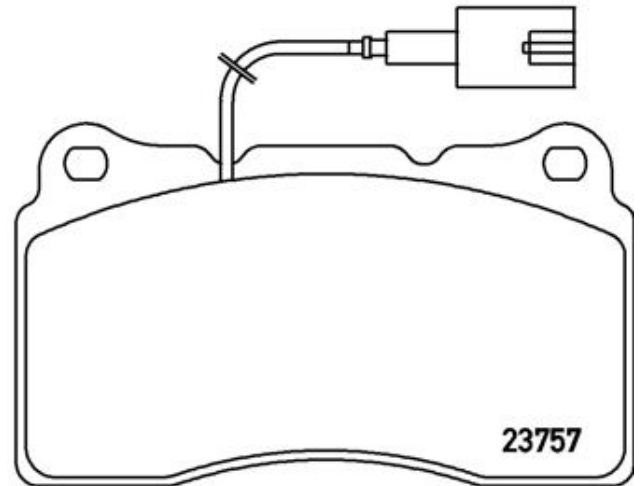
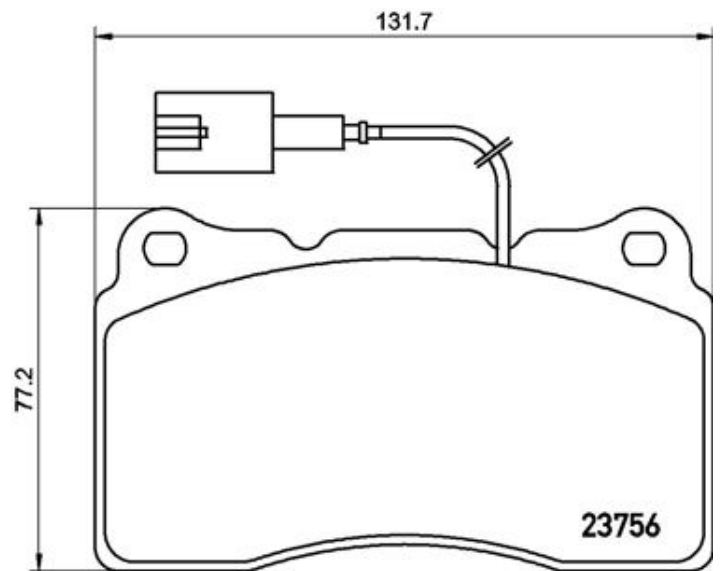

COMPATIBLE VEHICLES

COMPATIBLE OE PART NUMBERS

77366389

ALFA ROMEO