



# BRAKE PAD

## P 59 051

The P 59 051 brake pad is synonymous with reliability

The Brembo brake pad guarantees ultimate safety when braking thanks to the use of more than 100 different compounds, designed according to the type of vehicle and use. Stopping distances reduced to a minimum, maximum driving comfort and silent operation are the most important features of Brembo materials. Brembo brake pads are supplied together with an extensive range of accessories and assembly kits for professional-standard installation.



- ✓ OE-equivalent
- ✓ Brembo quality
- ✓ ECE-R90 certificate
- ✓ Safety
- ✓ Performance
- ✓ Comfort
- ✓ With accessories

### Technical specifications

EAN code <b>8020584061558</b>	Axle <b>Front</b>	Thickness <b>18 mm</b>
Width <b>123 mm</b>	Height <b>53 mm</b>	Braking system <b>Bosch</b>
Wear indicator <b>Acoustic</b>	WVA number <b>24288,23982</b>	Accessories <b>With accessories With brake caliper bolts With anti-squeal shim</b>

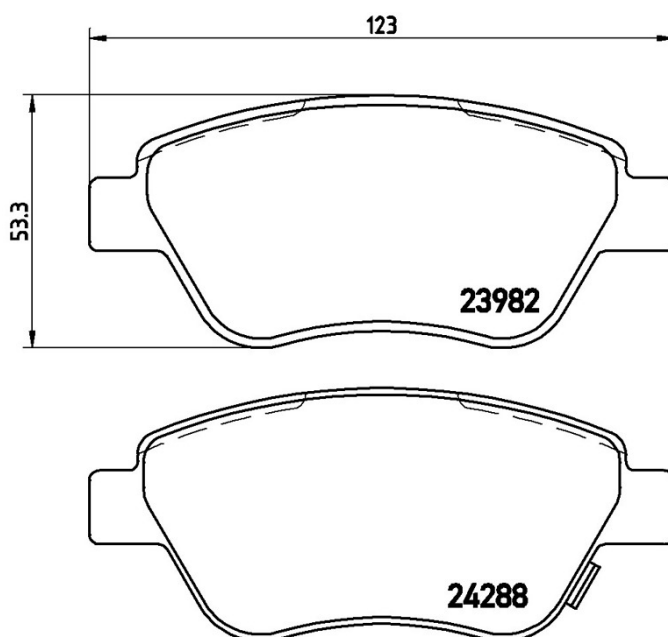

**COMPATIBLE VEHICLES**

## COMPATIBLE OE PART NUMBERS

93189815 GENERAL MOTORS

---

93191698 GENERAL MOTORS

---

1605258 OPEL

---

1605353 OPEL

---

1605357 OPEL

---

1605359 OPEL

---

1680880580 OPEL

---

93167073 OPEL

---

93169174 OPEL

---

93169254 OPEL

---

93191697 OPEL

---

93191698 OPEL

---

1605226 VAUXHALL

---

93169174 VAUXHALL

---

93169254 VAUXHALL

---