



# BRAKE DISC PAINTED

## 09.9922.11

The 09.9922.11 painted brake disc is synonymous with reliability

The Brembo brake disc with special UV paint treatment guarantees superior corrosion resistance for the product, thanks to the protective coating on the outer edges and on the disc hub. The UV paint not only gives the disc a clean, shiny appearance but is also beneficial for the environment as the water-based UV paint treatment does not require the use of chemical solvents and is a low energy consumption process.



- ✓ OE-equivalent
- ✓ Brembo quality
- ✓ ECE-R90 certificate
- ✓ Safety
- ✓ High carbon
- ✓ Anti-corrosion
- ✓ Fastening screws

### Technical specifications



EAN code	Axle	Diameter Ø
<b>8020584992210</b>	<b>Front</b>	<b>348 mm</b>
Thickness (TH)	Height (A)	Number of holes (C)
<b>30 mm</b>	<b>62 mm</b>	<b>5</b>
Brake disc type	Centering (B)	Min. thickness
<b>Ventilated</b>	<b>75 mm</b>	<b>28,4 mm</b>

Tightening torque  
**140 Nm**

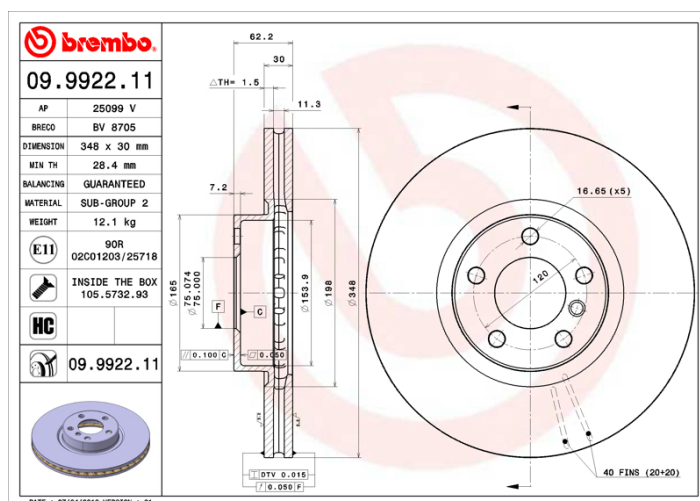

**COMPATIBLE VEHICLES**

## COMPATIBLE OE PART NUMBERS

34116771986 BMW

---

34116793244 BMW

---

34116868938 BMW

---

34116886477 BMW

---