



SPORT | TY3 BRAKE DISC

59.E114.22

The 59.E114.22 brake disc is synonymous with reliability

Type-3 slotting used to distinguish the Brembo SPORT | TY3 brake disc is widely used in professional motorsports. It therefore offers superior initial response with excellent release characteristics, improving braking performance while giving the vehicle an aggressive appearance. The Brembo logo on the braking surface adds an exclusive and unique touch to the vehicle. The SPORT | TY3 brake discs are plug-and-play since they replace OE discs directly.



- ✓ OE-equivalent
- ✓ Brembo quality
- ✓ ECE-R90 certificate
- ✓ Safety
- ✓ Performance
- ✓ Comfort
- ✓ Sports driving
- ✓ Sparty look

Technical specifications



Diameter	Thickness (TH)	Height (A)
326 mm	30 mm	53 mm
Number of holes (C)	Brake disc type	Centering
5	Solid	58 mm
Min. thickness	Tightening torque	Axle
28,5 mm	100 Nm	Front
Units per box	EAN code	
1	8020584604939	

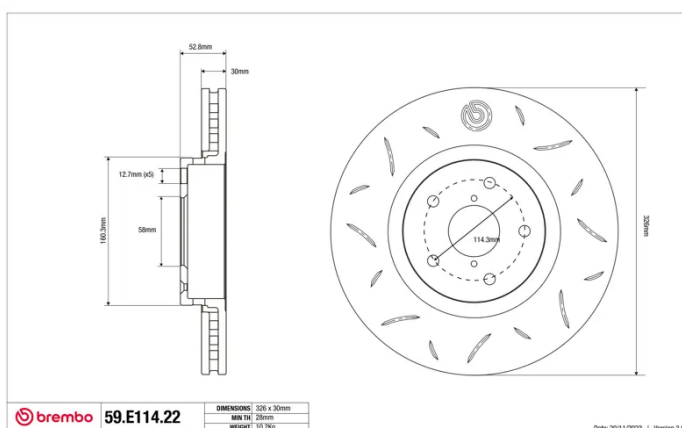

59.E114.22

DIMENSIONI	226 x 30mm
MIN TH	28mm
WEIGHT	10.2kg

Date: 2011/2023 | Version: 3.00